

USDA Forest Service National Sawyer Training: Developing Thinking Sawyers



Student Guide: Classroom

USDA Forest Service National Sawyer Training:
Developing Thinking Sawyers
Module 2.1: Chain Saw Basics, Maintenance, and Operation

This page intentionally left blank.

**USDA Forest Service National Sawyer Training:
Developing Thinking Sawyers**

Module 2.1: Chain Saw Basics, Maintenance, and Operation

Table of Contents

Module 2.1: Chain Saw Basics, Maintenance, and Operation	1
Introduction	1
Module Topics	1
Objectives	1
Pework Review	1
Chain Saw Basics.....	4
Chain Saw Components	4
Guide Bars.....	6
Guide Bar Parts	6
Saw Chain	8
Activity	9
How a Cutter Tooth Works	9
Chain Saw Maintenance	11
Major Systems	11
Demonstration: Inspection and Bar and Chain Installation.....	12
Video: Chain Tension	13
Demonstration: Correct Chain Tension.....	13
Video: How to Properly Maintain and Sharpen Chains	13
Gas-Powered Chain Saws.....	13
Fueling a Chain Saw	14
What is a Fuel Geyser?.....	14
Chain Saw Operation	15
Five-Point Safety Check.....	16
Holding the Chain Saw	16
Video: Five-Point Safety Check and Starting a Chain Saw	17
General Guidelines.....	17
Ways to Support the Chain Saw	17
Reactive Forces.....	19
Pushback.....	19

USDA Forest Service National Sawyer Training:
Developing Thinking Sawyers
Module 2.1: Chain Saw Basics, Maintenance, and Operation

Pull-In.....	20
Kickback	20
Boring	21
Knowledge Check	22
Summary	23

List of Figures

Figure 2.1.1—Chain saw components.....	4
Figure 2.1.2—Chain saw components, continued.....	5
Figure 2.1.3—Guide bar parts.....	6
Figure 2.1.4—Guide bar types.....	7
Figure 2.1.5—Guide bar markings.....	7
Figure 2.1.6—The major components of a chain saw.....	8
Figure 2.1.7—The five parts of a cutter tooth.....	9
Figure 2.1.8—Cutter teeth types.....	10
Figure 2.1.9—Cutter sequence types	10
Figure 2.1.10—The chain saw safety system.....	11
Figure 2.1.11—The chain saw powerhead system.....	11
Figure 2.1.12—The chain saw bar and chain system.....	12
Figure 2.1.13—A fuel geyser warning poster.....	15
Figure 2.1.14—The five-point safety check.....	16
Figure 2.1.15—The correct way to hold a chain saw.....	16
Figure 2.1.16—The proper stance while holding a chain saw.....	17
Figure 2.1.17—Starting a chain saw on the ground.....	18
Figure 2.1.18—Starting a chain saw between the legs.....	18
Figure 2.1.19—Starting a chain saw supported by a log.....	19
Figure 2.1.20—Pushback force.....	19
Figure 2.1.21—Pull-in force.....	20
Figure 2.1.22—Kickback danger zone.....	20
Figure 2.1.23—A kickback.....	21
Figure 2.1.23—Boring steps.....	21

USDA Forest Service National Sawyer Training:
Developing Thinking Sawyers
Module 2.1: Chain Saw Basics, Maintenance, and Operation

This page intentionally left blank.

**USDA Forest Service National Sawyer Training:
Developing Thinking Sawyers**
Module 2.1: Chain Saw Basics, Maintenance, and Operation

Module 2.1: Chain Saw Basics, Maintenance, and Operation

Introduction

Module 2.1 covers how chain saws work, their components, how they operate, and the correct way to fuel and start a chain saw. The instructor will explain chain saw operation during class and will provide you time to practice what you've learned.

Before you try to start a chain saw for the first time, it is important to understand its basic components and how they work. It is also important to understand the engineered safety features of the saw you are handling.

Module Topics

- Chain Saw Basics
 - Chain Saw Components
- Chain Saw Maintenance
 - Care and Maintenance
- Chain Saw Operation
 - Five-Point Safety Check
 - Proper Fueling
 - Starting a Chain Saw
- Reactive Forces

Objectives

When you complete this module, you will be able to:

- Identify the parts of a chain saw.
- Perform the five-point safety check.
- Discuss fueling safety procedures.
- Start a chain saw.
- Describe reactive forces.
- List the guidelines for transporting a chain saw.

Pework Review

Owner's Manual

The chain saw owner's manual is a critical document that every chain saw operator must be familiar with. **Do not throw it away.**

USDA Forest Service National Sawyer Training: Developing Thinking Sawyers

Module 2.1: Chain Saw Basics, Maintenance, and Operation

The manual contains important information that is unique to each chain saw, such as:

- Assembly
- Fuel handling
- Maintenance intervals
- Parts and controls
- Safety precautions
- Starting and stopping procedures
- Technical data
- Working techniques

Transporting Basics

Basic guidelines for transporting a chain saw and fuel include:

- Never transport a chain saw or fuel in the passenger compartment or in an enclosed vehicle.
- Cover the bar with a sheath during transport to prevent damage to the saw cutter tooth or other property.
- When you transport a chain saw over your shoulder, you must use a sheath that covers the bumper spikes (dogs) and muffler. This will greatly decrease the risk of serious physical harm. A sturdy shoulder pad is also recommended.
- When transporting by aircraft or watercraft, follow the aircraft personnel or pilot's instructions.
- When transporting by pack stock, follow the packer's instructions.

Required Equipment

When operating a chain saw, required equipment includes:

- A chain saw bar wrench
- A chain file
- An approved safety container for chain saw fuel and bar oil
- Proper wedges for the specific sawing project or activity
- A 3- to 5-pound single-bit ax (minimum handle length of 20 inches) or a commercially made pounder
- A bar cover that adequately covers the chain and bumper spikes (dogs) when you carry the chain saw on your shoulder or a cover that is adequate for carrying the chain saw at your side

Recommended extra equipment:

- Spare sprocket
- Extra chain
- Spare spark plug
- Filing guide

USDA Forest Service National Sawyer Training: Developing Thinking Sawyers

Module 2.1: Chain Saw Basics, Maintenance, and Operation

- Raker file/depth gauge file
- E-clip/sprocket retaining clip
- Bearings and bearing grease
- Extra bar nuts
- Various nut drivers
- Tuning screwdriver
- Extra pull cord
- Tachometer
- Bar groove cleaning tool

Troubleshooting

Remember to always consult the owner's manual. Not all chain saw makes and models are the same.

Use table 2.1.2 in the prework packet as a basic troubleshooting guide.

Questions

What are some guidelines for selecting a chain saw?

Why should you always read and keep the owner's manual?

What items do you check in the five-point safety check?

What are some guidelines for transporting a chain saw?

**USDA Forest Service National Sawyer Training:
Developing Thinking Sawyers**
Module 2.1: Chain Saw Basics, Maintenance, and Operation

Describe three ways to start a chain saw.

Chain Saw Basics

There are two basic types of power saws available on the market today: gas-powered and battery-powered. When selecting the right tool for the job, you should consider powerhead size, bar length, your skill level, and the specific task at hand.

Personal fitness and strength are other considerations, as these factors can dramatically affect your ability to handle, hold, and manipulate a chain saw. Bigger is not always better. Over a short period of time, handling even a 12-pound chain saw can become physically challenging. As fatigue sets in, your risk of injury greatly increases.

Chain Saw Components

When you first purchase or receive a chain saw, become familiar with the make and model and the location of the components (figures 2.1.1 and 2.1.2).

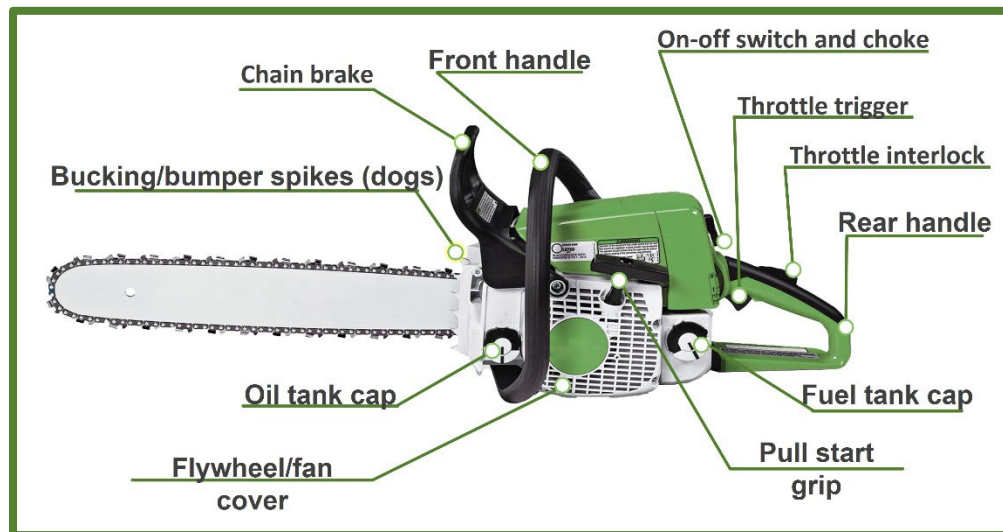

Figure 2.1.1—Chain saw components.

Chain Saw Components

- **Bucking/bumper spikes (dogs):** Used to help hold the saw steady against wood.
- **Chain brake:** Stops the chain's motion.
- **Front handle:** Used to hold and balance the saw.

USDA Forest Service National Sawyer Training: Developing Thinking Sawyers

Module 2.1: Chain Saw Basics, Maintenance, and Operation

- **On/off switch:** Turns the saw on and off.
- **Throttle trigger:** Controls the speed of the engine.
- **Throttle interlock:** Prevents the throttle from engaging unless the interlock is depressed on the handle.
- **Rear handle:** Used to hold the saw.
- **Fuel tank cap:** Provides access to the fuel tank and seals the tank to prevent spillage.
- **Pull-start grip:** A rubber or plastic handle attached to the starter pull rope.
- **Flywheel cover:** Covers the flywheel and holds the recoil starter.
- **Oil tank cap:** Provides access to the oil tank and seals the tank to prevent spillage.

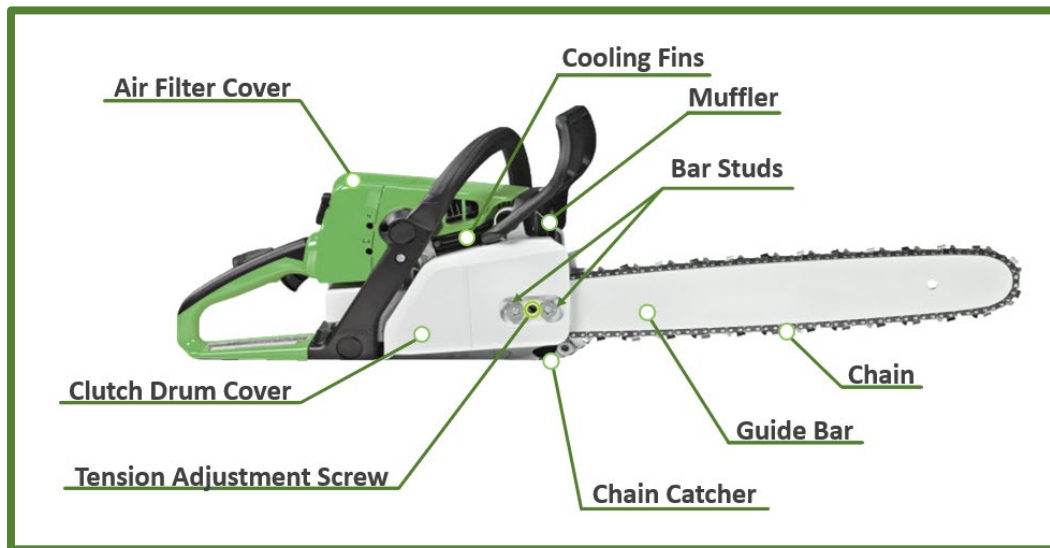

Figure 2.1.2—Chain saw components, continued.

- **Air filter cover:** Stops dirt, dust, and sawdust from entering the air filter, thereby protecting the carburetor.
- **Cooling fins:** Provide cooling to the motor cylinder.
- **Muffler:** Reduces exhaust noise.
- **Bar studs:** Hold the bar in place.
- **Chain catcher:** Prevents the chain from contacting you in the event of a broken or thrown chain.
- **Tension adjustment screw:** Moves the guide bar to maintain proper tension on the saw chain.
- **Clutch drum cover:** Covers the sprocket and clutch.
- **Clutch drum (under the cover):** Couples the engine to the chain sprocket when you accelerate the engine above idle speed.

USDA Forest Service National Sawyer Training: Developing Thinking Sawyers

Module 2.1: Chain Saw Basics, Maintenance, and Operation

Not shown

- **Chain sprocket:** The toothed wheel that drives the saw chain. Sprockets come in different styles and sizes (e.g., rim sprocket, spur sprocket).
- **Oiler adjustment screw:** Adjusts the amount of oil dispensed to the bar and chain.
- **Choke:** Used for starting a cold saw.
- **Fuel filter:** Prevents dirt and other contaminants from entering the saw's carburetor.
- **Spark plug:** Ignites fuel in the cylinder.
- **Decompression valve:** Reduces pressure in the cylinder head to enable easier starting.
- **Directional marks (Gunning Sights):** Used for aiming the undercut and backcut.

Guide Bars

Figure 2.1.3 shows a typical guide bar and its components.

Guide Bar Parts

Guide bars have several standard features, including:

- Motor mount section
 - **Chain-tensioning pin hole:** Where you insert the chain tension pin.
 - **Oil hole:** Where chain oil from the oiler flows to the chain drivers along the guide bar groove.
 - **Mounting slot:** Where you insert the guide bar mounting studs to hold the guide bar in place.
- Guide bar body section
 - **Guide bar rails:** The tie strap for the chain rides on top of these rails.
 - **Guide bar groove:** Where the chain drivers ride to guide the cutting teeth around the guide bar.
- Sprocket tip section
 - **Sprocket tip:** Toothed sprocket that guides the chain around the tip of the bar.

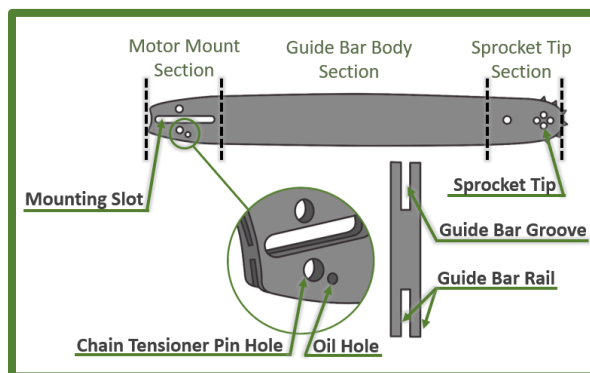

Figure 2.1.3—Guide bar parts.

Types of Guide Bars

Guide bars (figure 2.1.4) come in a wide variety of sizes and have many uses. You must select a bar sized properly for the powerhead and the job. Let's first become familiar with the types of guide bars:

- **Standard:** The bar tip has a roller sprocket for reduced friction and wear.

USDA Forest Service National Sawyer Training: Developing Thinking Sawyers

Module 2.1: Chain Saw Basics, Maintenance, and Operation

- **Lightweight:** Along with the features of the standard bar, these bars have aluminum inserts that reduce some weight. The weight difference is most noticeable on longer bars (note that the inserts can make these bars less rigid).



Figure 2.1.4—Guide bar types.

Guide Bar Markings

Guide bars are marked with information (figure 2.1.5) that references the:

- Bar length
- Number of drivers for the chain used
- Pitch of chain to use
- Gauge of chain to use

Use the bar that is specifically manufactured for the make and model of your saw.

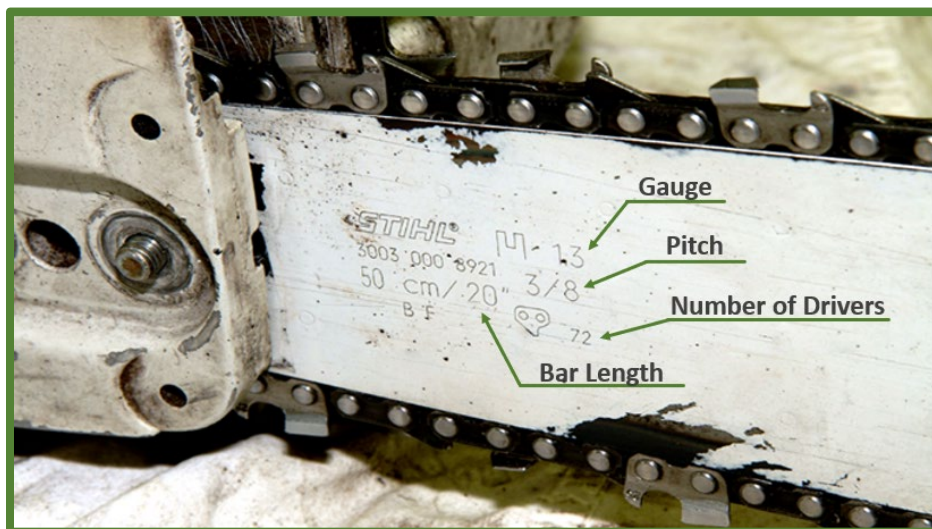

Figure 2.1.5—Guide bar markings.

USDA Forest Service National Sawyer Training: Developing Thinking Sawyers

Module 2.1: Chain Saw Basics, Maintenance, and Operation

Gauge, Pitch, and Number of Drivers

Not all chains fit every bar. Not all bars fit every chain saw. You should understand and use the right bar and chain combinations. It is important that the **gauge and pitch** of the saw chain, guide bar, and sprocket all match.

- **Gauge:** A measurement of the thickness of the drive link. It corresponds to the groove in the bar.
 - The bar gauge and chain gauge must match. The most common gauges are .050-inch, .058-inch, and .063-inch.
- **Pitch:** A measurement between rivets.
 - To determine pitch, measure the distance between three rivets and divide by 2.
 - The most common pitches are .325-inch, $\frac{3}{8}$ -inch, and .404-inch.
 - The pitch of the drive sprocket must match the pitch of the bar nose sprocket.
- **Number of drivers:** The length of the bar dictates the number of drivers necessary on a chain.

Things you need to know to order a new chain:

- Gauge
- Pitch
- Number of drivers
- Cutter type

Saw Chain

- A saw chain has four major components (figure 2.1.6):
 - **Rivet:** Holds the parts of the chain together and allows them to rotate.
 - **Drive link:** Guides the chain around the bar and transfers rotational energy from the drive sprocket.
 - **Tie strap:** Links the cutter tooth to the drive link.
 - **Cutter tooth:** Does the cutting. The saw chain has left- and right-hand cutters that enable the chain to cut evenly through the wood.

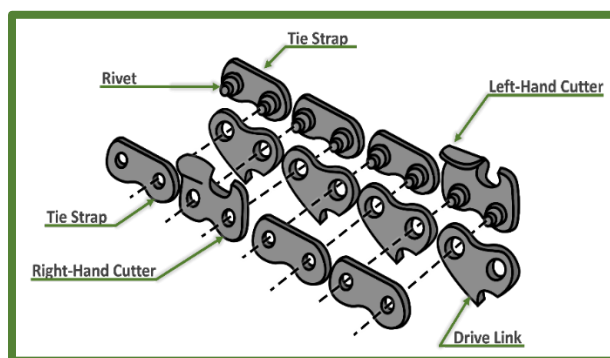

Figure 2.1.6—The major components of a chain saw.

USDA Forest Service National Sawyer Training: Developing Thinking Sawyers

Module 2.1: Chain Saw Basics, Maintenance, and Operation

Activity

Follow the instructor's directions for a class activity.

How a Cutter Tooth Works

A cutter tooth has five distinct parts:

- **Depth gauge:** The depth gauge (commonly referred to as the raker) regulates the thickness of the wood chip the chain saw will remove. If you file the depth gauge too low, the saw chain will jump, jerk, and chatter, causing the motor to bog down or lose power. If you don't file the depth gauge enough (too high), the chain will not cut enough wood.

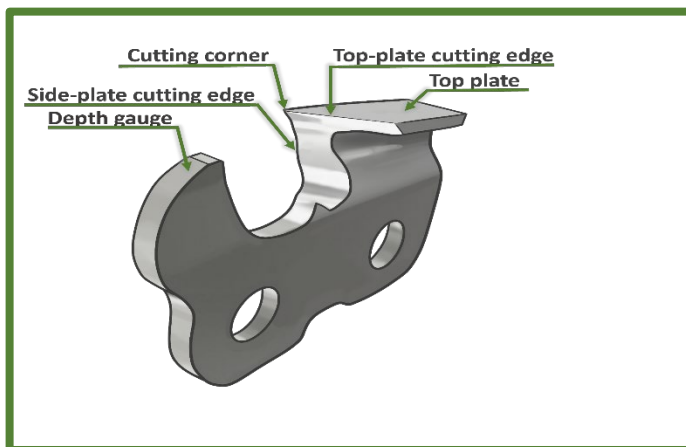

Figure 2.1.7—The five parts of a cutter tooth.

- **Cutting corner:** The cutting corner starts the cut into the wood fiber. If the point is rolled over or dulled from hitting dirt, rocks, or metal, you must sharpen it for it to work correctly.
- **Top plate:** The top plate starts the separation of the wood chip from the kerf. It also regulates the kerf width.
- **Side plate:** The side plate does most of the cutting by severing the long fibers in the kerf.
- **Chisel:** The chisel angle is on the front of the top plate. This angle separates the wood chip from the kerf. The chisel angle works in unison with the depth gauge.

Important: Always follow the specifications for the type of chain you use.

Cutter Types

The three most common types of cutter teeth are chipper, chisel, and semi-chisel (figure 2.1.8).

- **Chipper:** The easiest to file, it will tolerate the most dirt and dust.
- **Chisel:** The most aggressive cutter type. There are two types of chisel chain: square ground and round ground. You can use a round file or a specialized file to sharpen chisel chain. Square ground can be more difficult to file than other types of chain. Chisel chain does not tolerate dirty cutting conditions.
- **Semi-chisel:** A less aggressive cutter type than chisel. Use a round file to file semi-chisel chain. Semi-chisel chain tolerates dirt and dust.

USDA Forest Service National Sawyer Training:
Developing Thinking Sawyers

Module 2.1: Chain Saw Basics, Maintenance, and Operation

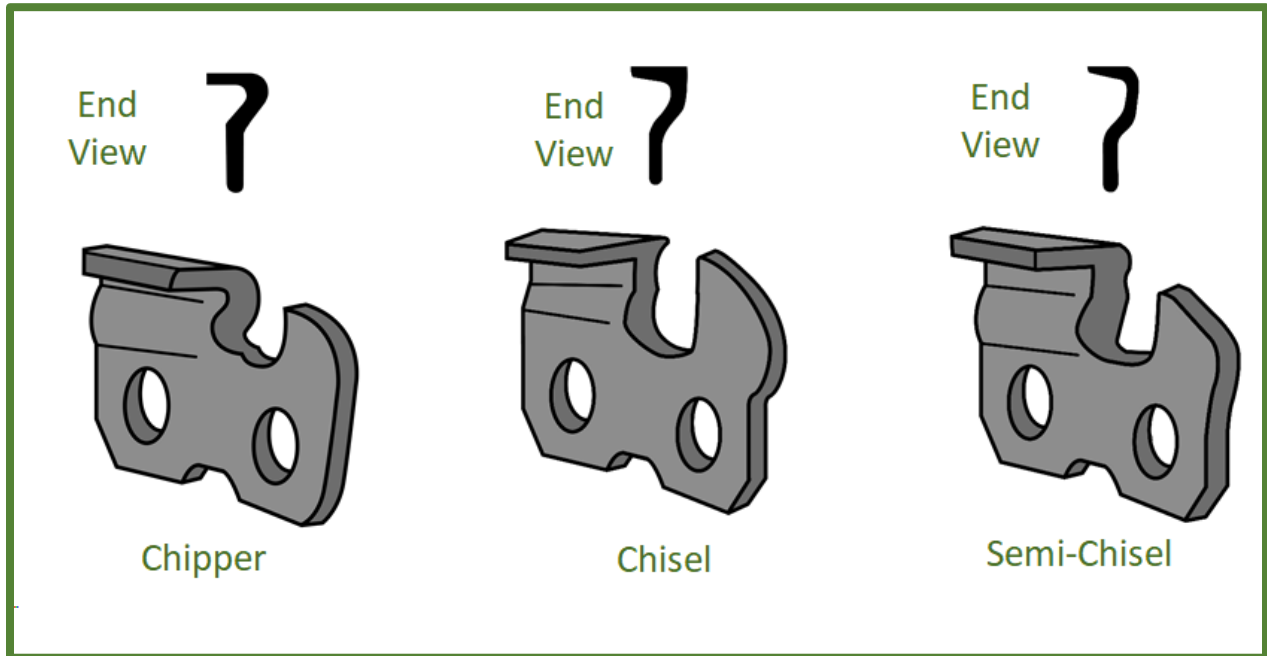

Figure 2.1.8—Cutter teeth types.

Cutter Sequence

The three types of cutter sequences are standard (or full comp), semi-skip, and full-skip (figure 2.1.9).

- **Standard/full comp:** Has the most cutting teeth of the three sequences. Its many teeth make it the smoothest and fastest cutting. Usually found on run-on saws with short- to medium-length bars or used for jobs that require extensive brushing or limbing.
- **Semi-skip:** A compromise between standard and full-skip sequence. Half its teeth are close together, like standard, and half are like full-skip. Good for most applications.

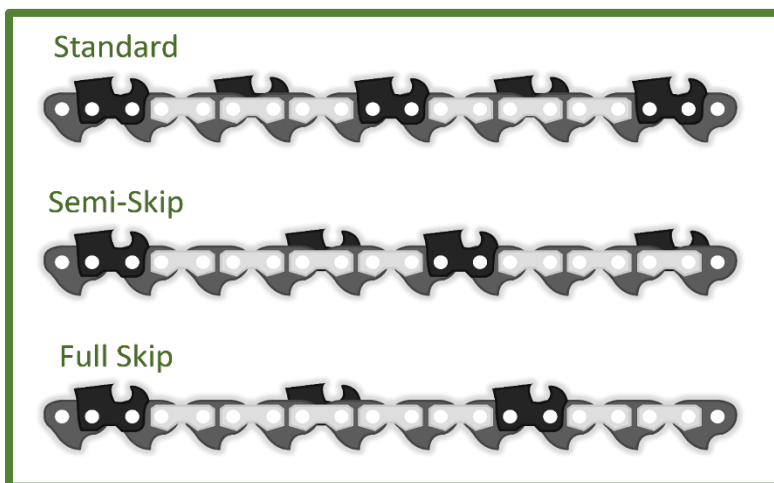

Figure 2.1.9—Cutter sequence types

USDA Forest Service National Sawyer Training: Developing Thinking Sawyers

Module 2.1: Chain Saw Basics, Maintenance, and Operation

- **Skip:** Best for running on long bars and for cutting large, softwood trees. One benefit is that it takes less time to sharpen than the other sequences. Some disadvantages include its lack of cutter teeth (making it grabby in short cuts), its high kickback potential, and its tendency to vibrate. Not a good choice for brushing or limbing.

Chain Saw Maintenance

A properly maintained saw improves performance, reduces downtime, requires less effort to operate, reduces fatigue, and minimizes operator risk.

The goal of this section is to educate you on basic, routine saw maintenance to keep your saw performing safely and as designed.

Major Systems

There are three major systems on a chain saw that you must maintain: the safety system, the powerhead system, and the bar and chain system.

The **safety system** includes the chain brake, chain catcher, throttle interlock, antivibration system, and spark arrester (figure 2.1.10).

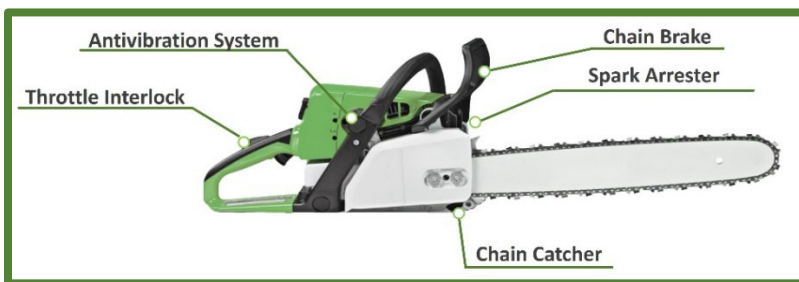

Figure 2.1.10—The chain saw safety system.

The **powerhead system** includes the handlebar, decompression valve, cylinder cooling fins, spark plug, air filter, carburetor, fuel filter, fuel tank, fan housing, and flywheel fins (figure 2.1.11).

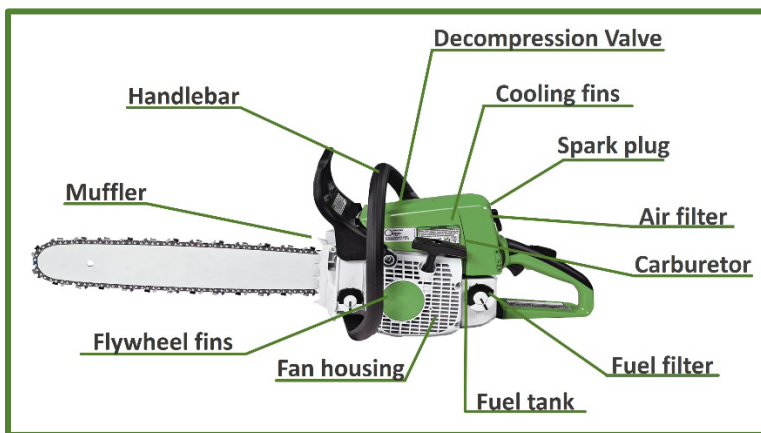

Figure 2.1.11—The chain saw powerhead system.

USDA Forest Service National Sawyer Training: Developing Thinking Sawyers

Module 2.1: Chain Saw Basics, Maintenance, and Operation

The **bar and chain system** includes the guide bar, oilway, chain tensioner, oil flow adjuster, chain components, sprocket, and drum (figure 2.1.12).

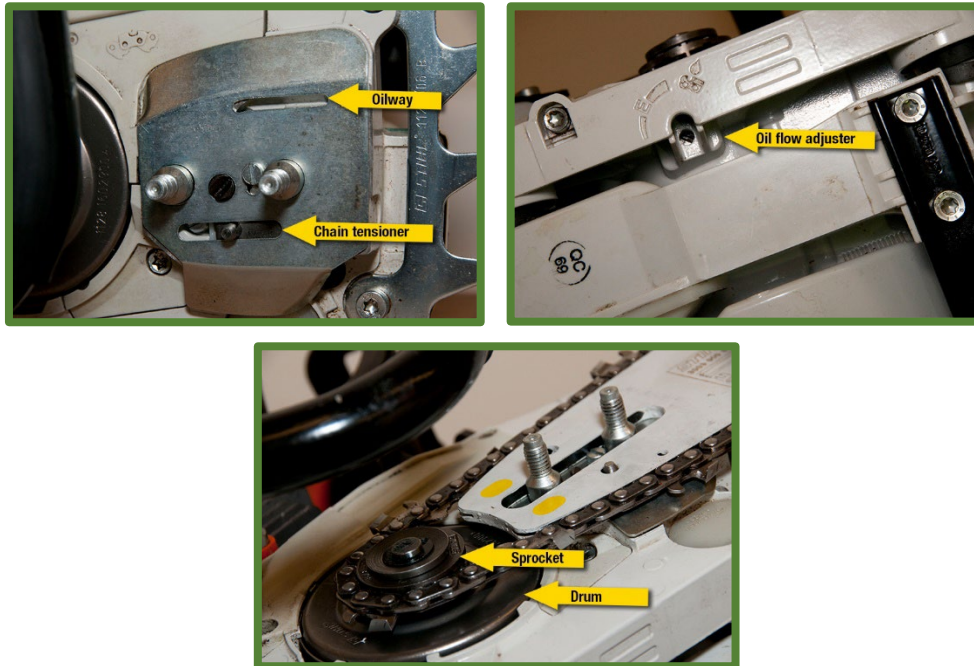

Figure 2.1.12—The chain saw bar and chain system.

Demonstration: Inspection and Bar and Chain Installation

To reduce downtime, you should do a routine visual inspection of the bar and chain components on the saw:

1. Wear gloves.
2. Remove the clutch cover by disengaging the chain brake and removing the bar nuts.
3. Remove the bar and chain. (**Note:** It is important to rotate/flip the chain saw bar over when doing routine maintenance).
4. Inspect the chain.
5. Clean the bar channel groove oil ports, bar sprocket, and drive sprocket.
6. Adjust the chain tensioner so that it inserts into the bar adjustment hole.
7. Reinstall the bar and chain.
 - Fit the bar over the bar studs, making sure the chain is correctly oriented (cutting points point toward the powerhead on the bottom of the bar).
 - Place the chain over the drive sprocket, making sure the chain drives engage.
 - Fit the chain drivers into the bar groove along the length of the bar (top and bottom) and around the drive sprocket.
8. Replace the clutch cover. (**Note:** Some models have chain tensioners located in the clutch cover and others have them in the saw body. Regardless of the location, take care

USDA Forest Service National Sawyer Training: Developing Thinking Sawyers

Module 2.1: Chain Saw Basics, Maintenance, and Operation

to locate the adjustment pin through the bar adjustment hole when replacing the clutch cover).

9. Ensure that the chain brake is functioning.

“Some chain saw models have chain tensioners located in the clutch cover and others have them in the saw body. Regardless of the location, take care to insert the adjustment pin through the bar adjustment hole when replacing the clutch cover.”

Video: Chain Tension

Watch a video about proper chain tension, then discuss it with your instructor and the class.

Demonstration: Correct Chain Tension

1. With the bar nuts lightly installed, raise the tip of the bar.
2. Carefully move the bar and chain forward by turning the chain tensioner to remove slack, making sure the drivers remain in the bar slots and are properly located on the sprocket.
3. Pull down on the chain (at the middle of the bar) until three drivers just clear the bar rails. The chain should **snap** back in place.
4. Tighten the bar nuts. Do not overtighten because the studs can pull out of the case.

Remember: Refer to your owner’s manual for proper tensioning procedure.

Video: How to Properly Maintain and Sharpen Chains

Maintaining a sharp chain is critically important and will help improve your safety, reduce physical fatigue, and lessen the wear of the bar and powerhead. Pay attention to the amount of sawdust you generate; this is a great indicator of a dull chain (sawdust) or a sharp chain (woodchips).

Watch a video of a sawyer sharpening a saw chain, then discuss it with your instructor and the class.

Gas-Powered Chain Saws

Gas-powered chain saws have two-stroke motors that require a fuel-oil mixture. Chain saw fuel is most often mixed at a 50-to-1 ratio (50 parts gas to 1 part two-cycle oil). Follow the manufacturer’s recommendations, as they may vary.

USDA Forest Service National Sawyer Training:
Developing Thinking Sawyers
Module 2.1: Chain Saw Basics, Maintenance, and Operation

Mixing Fuel

To mix fuel for a chain saw:

1. Add the correct amount of two-stroke mix oil to the fuel container.
2. Add the correct amount of gasoline to the fuel container to obtain the correct fuel-to-oil ratio.
3. Cap the fuel container and shake the mixture for 20 to 30 seconds to ensure proper blending.

Notes:

- You should use the fuel-oil mixture within 30 days of mixing.
- Commercially produced, premixed fuel may also be available and has a longer shelf life. Refer to the manufacturer's guidance on shelf life.

Fueling a Chain Saw

You should always fuel the chain saw on bare ground at least 20 feet from any ignition source. Allow the chain saw to cool before refueling. You should also refill the bar oil when you refill the fuel.

To fuel a chain saw:

1. Wipe away accumulated sawdust and dirt from the gas and oil filler caps.
2. After filling, replace the fuel cap and wipe up any spillage.
3. Remove the oil cap and fill with bar oil.
4. Replace the oil cap and wipe up spillage.
5. Move at least 10 feet away from the fill site before you start the chain saw.

Note: While the order you use to refill the fuel and oil tanks on your saw is not critical, make it a habit of performing the task the same way each time to prevent filling the tank with the wrong fluid.

What is a Fuel Geyser?

A **fuel geyser** is the forceful expulsion of liquid and vapor fuel from the fuel tank caused by the rapid depressurization of the tank (figure 2.1.13). Heat and agitation cause the pressure increase. A delayed fuel geyser can occur after opening the fuel container.

Fuel geysers can occur anytime fuel, heat, and pressure combine in fuel transport containers or small, gas-powered engines, such as chain saws, leaf blowers, and portable pumps. Fuel geysers have resulted in injury when sprayed fuel and vapor have ignited.

What do I need to know to protect myself?

Along with the fueling procedures listed above, take the following precautions when fuel, heat, and pressure are present (these steps may prevent significant burns in the event of fuel spray):

USDA Forest Service National Sawyer Training: Developing Thinking Sawyers

Module 2.1: Chain Saw Basics, Maintenance, and Operation

- Always assume fuel tanks and fuel containers are pressurized
- Always check fuel levels before opening the fuel tank or filler cap; more than half a tank may geysers.
- Cover the fuel cap with a rag when opening to contain potential fuel geysers spray.
- Be extra vigilant when equipment is running poorly and the fuel level is above half a tank.
- Do not use fuel older than 1 month.

If the equipment is running poorly or you suspect vapor lock:

- Do not open the fuel cap. Relieving the pressure does not alleviate a **vapor lock**.
- Check the fuel level through the tank or use the bar oil level to gauge the fuel level.
 - If the fuel level is more than half full, **do not open the tank!**
- Allow the equipment to thoroughly cool. This can take more than 45 minutes.
 - Restart the equipment when it is cool.

It is **your** job to protect yourself and others. Know how to handle your equipment to avoid fuel geysers anytime fuel, heat, and pressure are present.

Chain Saw Operation

Because you must release one hand to pull the starter cord, which compromises your grip and some of the control that two-handed operation normally provides, take extra care each time you start a chain saw.

Important! Consult your owner's manual for the correct choke and switch settings for your saw.



Figure 2.1.13—A fuel geysers warning poster.

USDA Forest Service National Sawyer Training: Developing Thinking Sawyers

Module 2.1: Chain Saw Basics, Maintenance, and Operation

Five-Point Safety Check

Before starting a chain saw, conduct the five-point safety check (figure 2.1.14). Ensuring that all parts are in working order will help prevent injury during use.

The five inspection points for the safety check are:

1. Activate the chain brake to ensure that it locks and unlocks the chain properly.
2. Squeeze the trigger to ensure it is locked.
 - Squeeze again while pressing the interlock to ensure it unlocks.
3. Confirm the chain catch pin is present.
4. Check that the antivibration system and fasteners are tight.
5. Check that the spark arrester screen is present.

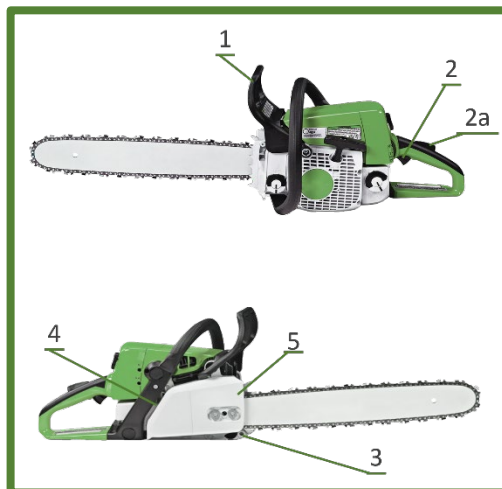

Figure 2.1.14—The five-point safety check.

Holding the Chain Saw

Your thumb and fingers should always be wrapped completely around the handlebar (figure 2.1.15). This is essential for maintaining control of the chain saw and for effective use of the chain brake.

Your grip on the chain saw should be firm but not overly tight. Chain saw safety features are designed for right-handed use.



Figure 2.1.15—The correct way to hold a chain saw.

USDA Forest Service National Sawyer Training: Developing Thinking Sawyers

Module 2.1: Chain Saw Basics, Maintenance, and Operation

Stance

You obtain the ideal stance when you maintain your balance with your feet spread apart, knees bent slightly, back straight, and a firm grip on the chain saw (figure 2.1.16). Proper ergonomics are critical for minimizing fatigue and possible injury.

Video: Five-Point Safety Check and Starting a Chain Saw

Watch a video of a sawyer starting a chain saw using various types of support. After the video ask, any questions you may have.

Note: Consult your owner's manual for the correct choke settings for the make and model of your chain saw.

General Guidelines

Note: Consult your owner's manual for the correct starting/stopping procedure for the make and model of your chain saw.

The following factors remain true no matter which of the three methods you use to start a chain saw:

- Wear all required PPE.
- **Always engage the chain brake** before attempting to start a chain saw.
- **Never drop start** a chain saw.
- Maintain a firm grip.
- Engage the choke when starting a cold saw.
- Pull the starter handle with your right hand and pull out the starter cord slowly until you feel resistance (as the starter pawls engage), then pull firmly and rapidly until the engine starts.
- Once the saw **pops**, open the choke.
- Give the starter rope short, brisk pulls until the saw starts.

Ways to Support the Chain Saw

The three acceptable methods for supporting a chain saw when starting it are on the ground, between your legs, or firmly supported by a stump, log, or branch.



Figure 2.1.16—The proper stance while holding a chain saw.

**USDA Forest Service National Sawyer Training:
Developing Thinking Sawyers**
Module 2.1: Chain Saw Basics, Maintenance, and Operation

On the ground (figure 2.1.17):

- Set the chain brake.
- Place the saw on firm ground in an open area.
- Grip the front handlebar firmly.
- Place the toe of your right foot into the rear handle or place your knee on top of the powerhead.
- Give the starter rope a firm, brisk pull.



Figure 2.1.17—Starting a chain saw on the ground.



Figure 2.1.18—Starting a chain saw between the legs.

Between the legs (figure 2.1.18):

1. Set the chain brake.
2. Place your left hand on the front handlebar.
3. Place the upper portion of the rear handlebar at the back of your right leg. Move your left leg over to firmly hold the saw against your right leg.
4. Give the starter rope a firm, brisk pull with your right hand.

**USDA Forest Service National Sawyer Training:
Developing Thinking Sawyers**
Module 2.1: Chain Saw Basics, Maintenance, and Operation

Firmly supported by a stump, log, or branch (figure 2.1.19):

1. Set the chain brake.
2. Place the bar of the saw over the available wood support.
3. Grip the rear handlebar.
4. Give the starter rope a firm, brisk pull.



Figure 2.1.19—Starting a chain saw supported by a log.

Reactive Forces

Always be aware of the potential reactive forces that the chain saw cutting system may cause. Reactive forces will vary at different points around the bar, and in the opposite direction from the direction the chain moves around the bar. The reactive forces that can result from using a chain saw are pushback, pull-in, and kickback.

Pushback

Pushback occurs when you use the top of the bar to cut (figure 2.1.20). When you use the top of the bar, energy transfers to you as the chain saw comes in contact with the wood. Although this reactive force is generally not as powerful as the one you experience during kickback, it can knock you off balance.

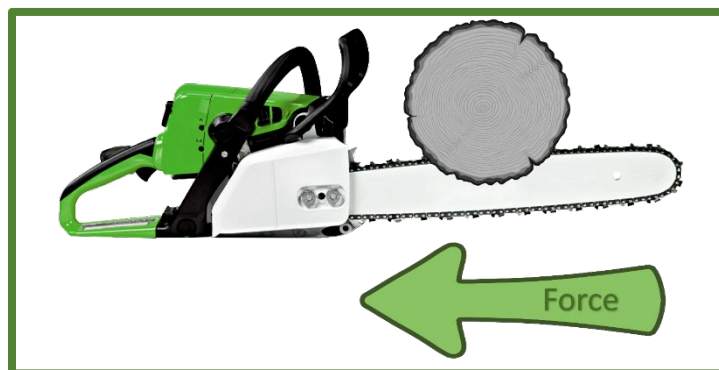

Figure 2.1.20—Pushback force.

USDA Forest Service National Sawyer Training: Developing Thinking Sawyers

Module 2.1: Chain Saw Basics, Maintenance, and Operation

Pull-In

Pull-in occurs when you cut with the bottom of the bar and energy transfers as the chain pulls the saw forward (figure 2.1.21). The tree or log will stop pull-in as the bucking spikes or as the powerhead contacts the wood.

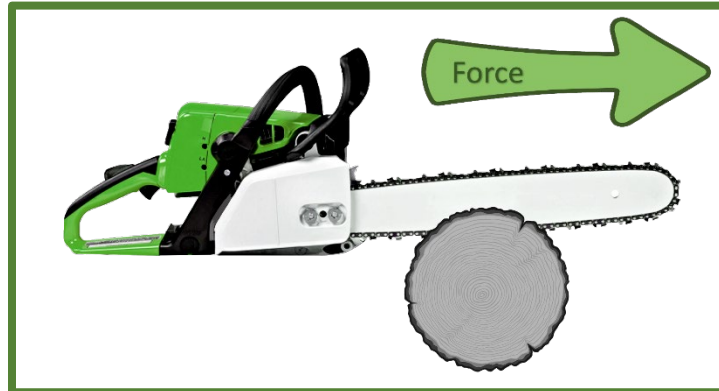

Figure 2.1.21—Pull-in force.

Kickback

Kickback can occur during saw operations when the upper portion of the bar nose contacts a solid object or becomes pinched (figures 2.1.22 and 2.1.23). This can force the bar violently up and back toward you in an uncontrolled arc.

Common kickback injuries involve saw cuts to the face, neck, and shoulder. Remain vigilant for this potential danger and plan all cuts to avoid it.

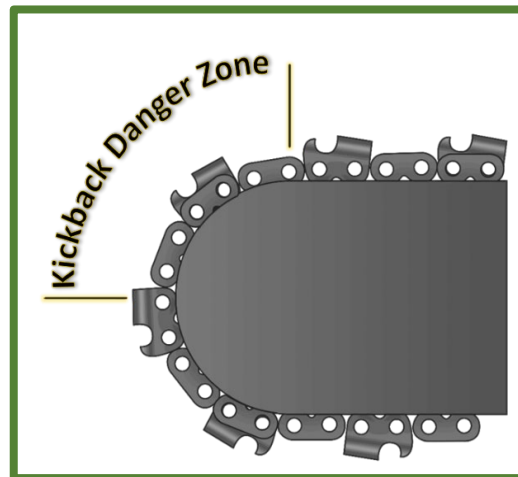

Figure 2.1.22—Kickback danger zone.

USDA Forest Service National Sawyer Training: Developing Thinking Sawyers

Module 2.1: Chain Saw Basics, Maintenance, and Operation

Avoiding Kickbacks

Hold the saw with both hands, securely gripping the handle and handlebar between your thumb and forefinger.

- Always be aware of the location of the bar nose and avoid cutting in the kickback danger zone (the upper quadrant of the bar nose).
- Avoid overreaching with the bar and contacting other objects with the upper quadrant of the bar nose.
- Allow the chain to come to a complete stop or engage the chain brake before pulling the saw smoothly from a cut.
- Position your body not to be in the kickback arc.



Figure 2.1.23—A kickback.

Boring

Boring is a technique you can use for a variety of reasons:

- To explore the condition of the wood fiber, validating the occurrence and extent of decay
- To help determine the extent and location of either tension or compression in a log
- To construct an exact hinge width

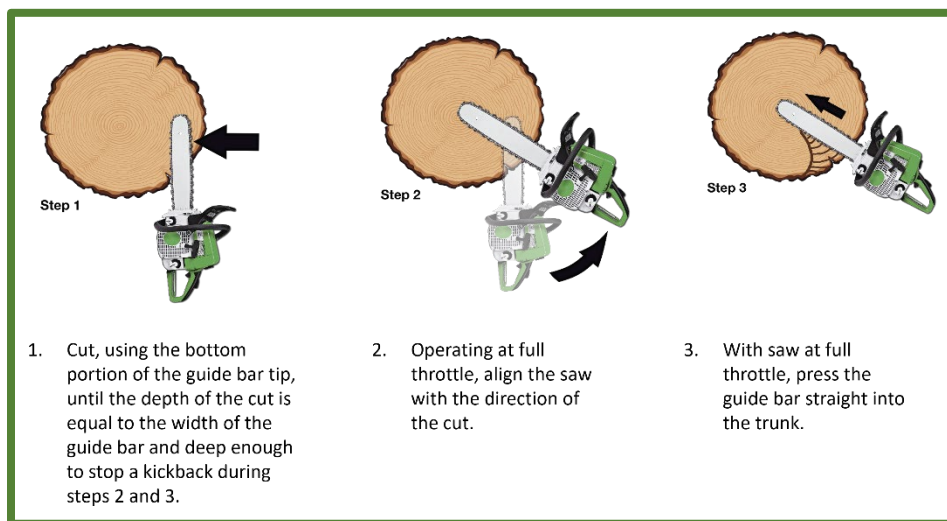

Figure 2.1.24—Boring steps.

**USDA Forest Service National Sawyer Training:
Developing Thinking Sawyers**
Module 2.1: Chain Saw Basics, Maintenance, and Operation

Knowledge Check

Where should you look to determine what type of chain you should order for your chain saw?

What are some guidelines for fueling a chain saw?

What is a fuel geyser?

How can you protect yourself from a fuel geyser?

What are the forms of reactive force?

**USDA Forest Service National Sawyer Training:
Developing Thinking Sawyers**
Module 2.1: Chain Saw Basics, Maintenance, and Operation

Summary

In this module you learned to:

- Identify the parts of a chain saw.
- Perform a five-point safety check.
- Explain fueling safety procedures.
- Start a chain saw.
- Explain reactive forces.
- List the guidelines for transporting a chain saw.

USDA Forest Service National Sawyer Training:
Developing Thinking Sawyers
Module 2.1: Chain Saw Basics, Maintenance, and Operation

This page intentionally left blank.
